



EST line

Accessories for
EST Operating tables



OPERATING THEATRE



Optional General Accessories



1



4



2

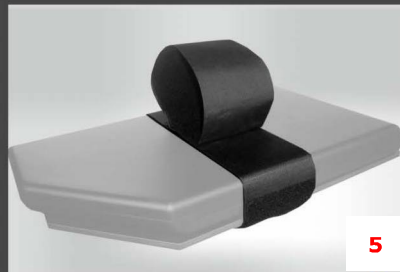

5



3



6



7



8

1) Cod. **EST-100100**

Arm rest

Integral poly pad, antistatic, 450mm long with attached clamp, horizontal and vertical adjustment, tiltable by socket joint.

(a pair of armrests are included as standard)

+

Cod. **EST-100101**

Arm/Leg belts

A pair of velcro strap belts as optional

2) Cod. **EST-100102**

Wristlet

With clamp, washable and exchangeable, textile velcro belt

3) Cod. **EST-100103**

Infusion pole

Upper section with 4 hooks, attachment clamp with socket joint

4) Cod. **EST-100104**

Body restraint belt

Washable velcro body belt

5) Cod. **EST-100105**

Leg restraint belt

Washable velcro belt for leg fixation, suitable for leg section

6) Cod. **EST-100106**

Wristlet

For attachment to anaesthesia frame EST-100107.

Washable and exchangeable textile velcro belt with attachment

7) Cod. **EST-100107**

Anaesthesia frame

With twist protection, adjustable height, lateral adjustment to make the frame to one side, with fixing clamps

8) Cod. **EST-100108**

Anaesthesia frame

With twist protection, adjustable height, with two fixing clamps

Optional General Accessories



9



11

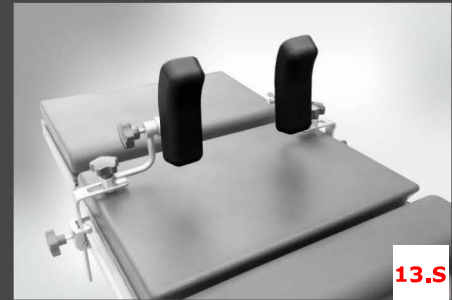

13.S



10



12



13.L

9) Cod. EST-100109

Fixing clamp

For codes :

- EST-100108 Anesthesia frame
- EST-100113.S/113.L Lateral support
- EST-100116 Foot/knee rest
- EST-100118 Arm protector

12) Cod. EST-100112

Fixing clamp

Hexagon hole, lateral angle adjust., prevent the insertion pole rotation, For code: EST-100132 Countertraction post

10) Cod. EST-100110

Fixing clamp

Round hole, Ø14mm, no-lateral angle adjustment.

For codes :

- EST-100100 Armrest
- EST-100103 Infusion pole
- EST-100106 Wristlet
- EST-100107 Anesthesia frame
- EST-100119 Instrument tray
- EST-100122 Tube holder
- EST-100130 Arm/hand board
- EST-100131 Arm/hand board
- EST-100134 Traction device
- EST-100161 Cross bar attachment

13.S) Cod. EST-100113.S

Shoulder support

Poly antistatic pad, width, lateral, angle and height are adjustable. Multifunctional pad 190x60mm



13.1

13.L) Cod. EST-100113.L

Lateral support

Poly antistatic pad, width, lateral, angle and height are adjustable. Multifunctional pad 190x60mm



13.2

13.1) Cod. EST-100113.1

Multifunction support

Width, lateral, angle and height are adjustable.

11) Cod. EST-100111

Fixing clamp

Round hole, Ø14mm, lateral angle adjustment.

For codes :

- EST-100117 Leg holder
- EST-100121 Instrument tray
- EST-100135 Knee pos. Device
- EST-100137 Rectal support
- EST-100164 Elbow holder
- EST-100181 Feet support
- EST-100182 Leg support

13.2) Cod. EST-100113.2

Pubis/sacrum/ sternum support

(Figure 2) 85x85 mm Covered foam pad, antistatic +

Cod. EST-100113.3

Back/buttock support

(Figure 3) 200x120 mm Covered foam pad, antistatic



13.3

13.3) Cod. EST-100260

Stainless steel lateral support



Optional General Accessories



- 14) Cod. **EST-100114**
Accessories rack
 Stainless steel square-section tubular frame with rails for attachment of accessories and 1 basket, antistatic castors with lock



- 15) Cod. **EST-100115**
Leg restraint straps
 1 pair, with pads, for split leg section, incl. clamps to attach to side rails

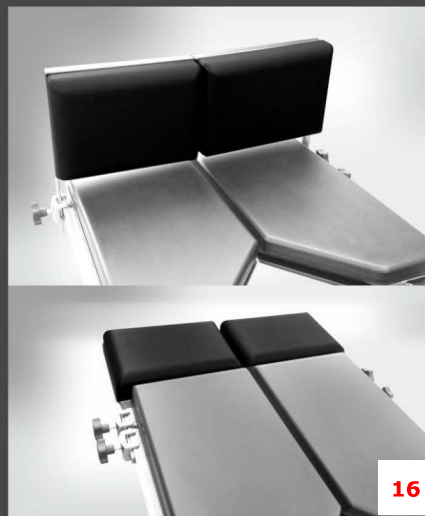

- 16) Cod. **EST-100116**
Foot/knee rests
 (1 included as standard) Attached on the sides by fixing clamps, can be folded down to serve as the table-top extension, 300x215 mm (WxD)

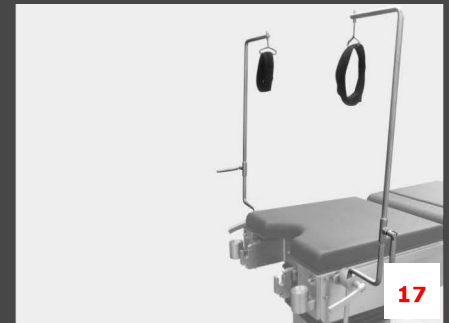

- 17) Cod. **EST-100117**
Leg holder (lithotomy)
 1 pair, with removable loops made of washable textile straps. Height & lateral adjustment. It requires fixing clamp EST-100111

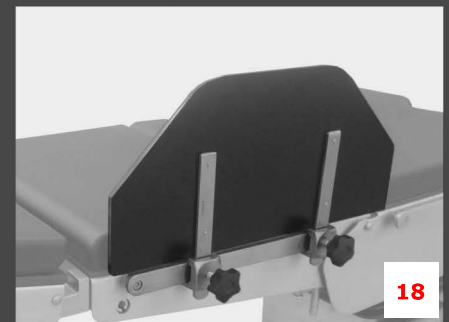

- 18) Cod. **EST-100118**
Arm protector
 It requires fixing clamp EST-100109

- 19) Cod. **EST-100119**
Instrument tray
 Adjustable height, it requires fixing clamp EST-100110
 Tray size: 400x300 mm
 Max Load: 6 kg



- 20) Cod. **EST-100120**
Instrument tray
 Mounted on the hooks of the table (without leg section)
 Tray size: 450x330 mm
 Max Load: 6 kg

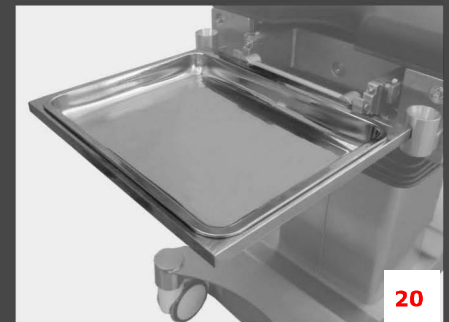

- 21) Cod. **EST-100121**
Instrument tray
 Height and lateral adjustment, it requires fixing clamp EST-100111
 Tray size: 450x330 mm
 Max Load: 6 kg

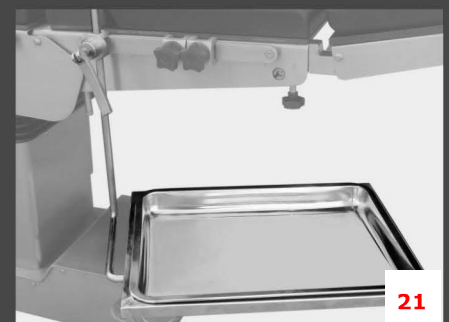

- 22) Cod. **EST-100122**
Tube holder
 (no pictures), for secure positioning of monitor cables

Accessories for orthopaedics, traumatology, spinal surgery and orthopaedic extension



1



5

- 1) Cod. **EST-100130**
Arm/hand operating board
 Radiolucent board with covered antistatic foam pad, with double-layer design suitable to X-ray. X-ray cassette holder can be placed underneath. 700x300 mm (WxD)



2



6

- 2) Cod. **EST-100131**
Arm/hand operating board
 Radiolucent board with covered antistatic foam pad, ergonomic shape for optimal access to the surgical field, suitable to C-arm 600x440 (WxD)

- 3) Cod. **EST-100132**
Countertraction post for upper arm
 Poly pad, max. load : 12kg, requires attachment clamp EST-101112

- 4) Cod. **EST-100133**
Humerus traction device
 +
 Cod. **EST-100134**
Weiberger traction device
 For hand and finger positioning and traction, hand plate and finger holder of plastic material, to be attached to upper arm positioning device suitable for C-arm, max. load 30kg



3



4

- 5) Cod. **EST-100135**
Cushion
 For intervertebral disc operations, also as protection for the chest, reducing pressure, keeping good respiratory and circulatory functions in the cervical and lumbar spinal surgery. 630x460x130 (WxDxH)

- 6) Cod. **EST-100136**
Knee positioning device
 Manual adjustment, with gel pad and fastening strap. Side rail attachment (requires attachment clamp EST-100111) Max. load 25kg

- 7) Cod. **EST-100137**
Rectal (abdomen) positioning support

Combined with EST-100116 for spinal surgery, rectal surgery, covered with antistatic poly pad, with height and lateral adjustment

- +
 Cod. **EST-100116**
Foot/knee rests
 (1 included as standard) Attached on the sides by fixing clamps, can be folded down to serve as the table-top extension, 300x215 mm (WxD)



7



Accessories for orthopaedics, traumatology, spinal surgery and orthopaedic extension



8) Cod. **EST-100138**

Axilla support

Padded, radiolucent with countertraction post, including clamps.

9) Cod. **EST-100139**

Elbow support

Swivelling via eccentric lever joint, including clamps. Recommended to use with EST-100133 & EST-100134 humerus traction and Weiberger traction device.



10) Cod. **EST-100140**

Shoulder surgery device

Self-operated type by use power of surgical table itself, placed instead of legsection, it is only compatible to the EST-XD2E. It includes also a head support (EST-100141) and an actuator (EST-100142)

Cod. EST-100141

Head support

For the shoulder surgery device.

Cod. EST-100142

Actuator

For the shoulder surgery device.



Extension device



1



2



3



1



5

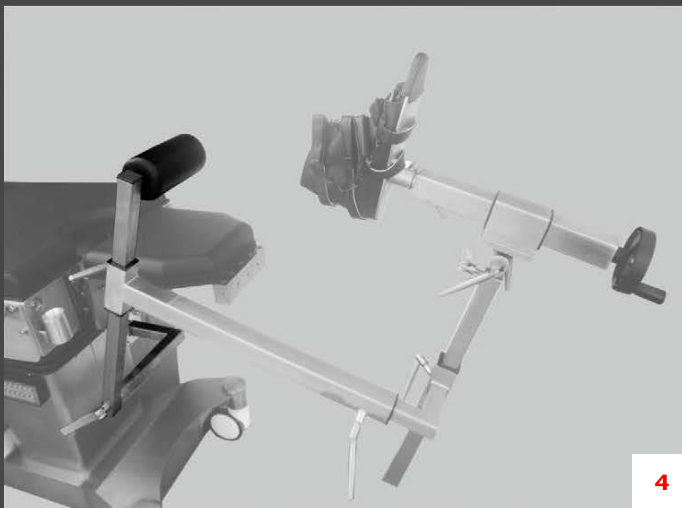

4

- Unobstructed access to the lower limbs for C-arm image intensifier and complete transillumination of the two axes, no any blind area for C-arm application
- Well-devised accessories for comfortable and precise positioning of the patient
- Including trolley, two supporting bars and EST-100151, EST-100152, EST-100154 and EST-100155(2 pieces)

2) Cod. EST-100151
Positioning board

For extension device positioning

3) Cod. EST-100152
Sacro post

(countertraction post for femur)

For surgery with the patient in lateral position

4) Cod. EST-100153
Tibia/fibula countertraction post

Countertraction post for tibia and fibula with radiolucent padded roll, height and inclinable adjustment for attachment to extension device EST-100150

5) Cod. EST-100154
Pelvis cast

The carbon-fiber countertraction post can be laterally moved

1) Cod. EST-100150

Sacro post extension device

For treatment of all kinds of lower limb fractures.
Main features:

- Fast, simple and secure attaching to the operating table.
- Modular structure for an optimal range of application



Extension device

6) Cod. **EST-100155**

Adult Foot rest

Extension part, shoe holder with adult shoe (1 pc).
Optional shoe for children
cod. EST-100155C (1 pc)



6

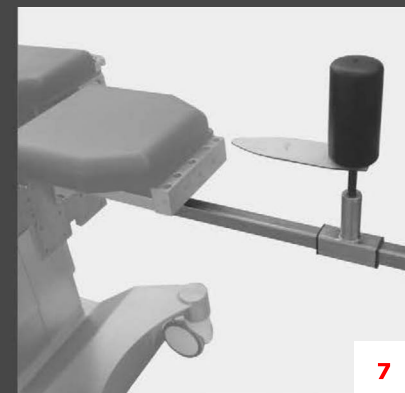

7

7) Cod. **EST-100156**

Pelvis support

Pelvis plaster adapter with pelvis support, with removable pelvis rest, adult as standard.
Optional for children cod. EST-100156C

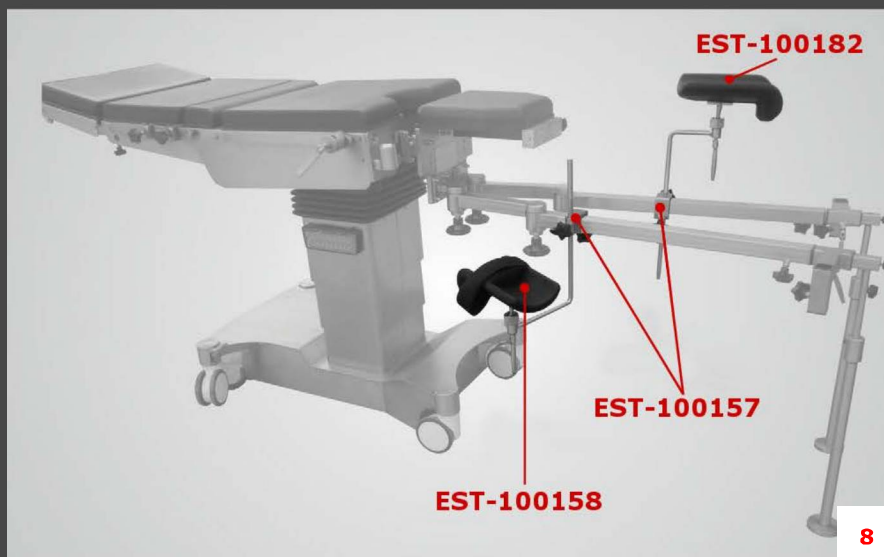

8

8) Cod. **EST-100157**

Fixing clamp

Only for EST-100158 and EST-100182 leg rests for EST-100150 extension device

8) Cod. **EST-100158**

Lower leg rests

Optional pair of velcro strap belts EST-100101

8) Cod. **EST-100182**

Upper leg rests

(a pair included as standard)
Optional pair of velcro strap belts EST-100101

9) Cod. **EST-100159**

Extension device

For treatment for legs traction, reset and legs operation.
Not suitable for C-arm.



9

Accessories for neurosurgery



1



2

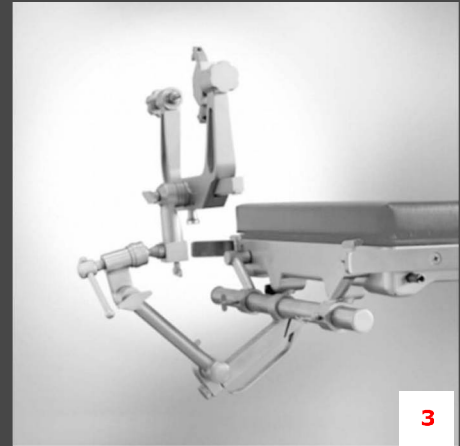

3

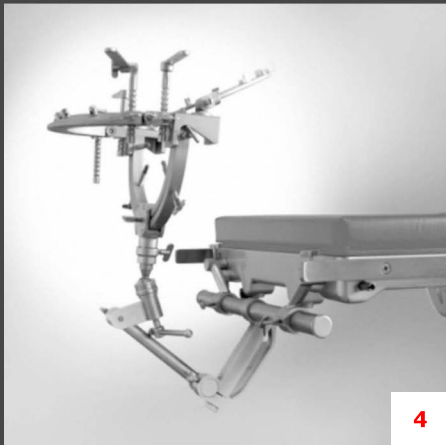

4



5

1) Cod. EST-100160

Head rest

1-section, pad head rest, optimal pressure distribution in prone and supine position. Max. load 15 kg

2) Cod. EST-100161

Cross bar attachment

Stainless steel, for seated positioning in neurosurgery, adjustment for different table widths. It requires two clamps EST-101110

3) Cod. EST-100162

Head skull clamp

For a secure and stable 3-point fixation of patient's head in supine, prone, lateral or sitting position. With 3 pins for adults.

4) Cod. EST-100163

Brain retractor system

Unobstructed access to the surgical field. An open ring is crucial for the skull base applications. Recommended for posterior fossa. Mini J-arm allows vertical and horizontal movements

5) Cod. EST-100164

Elbow holders

1 pair. For ENT and plastic surgery. Height and lateral adjustable, it requires fixing clamp EST-100111 and EST-100160 head rest.



Accessories for gynaecology and urology



1



4



5

1) Cod. **EST-100180**

Leg Support

1 Pair. Adjustable height and swivelling from the foot end, servo-assisted, plastic support with gel pad for foot and lower leg, adjustable to all directions. Special attachment clamps already included.

2) Cod. **EST-100181**

Feet Support

1 Pair. Specially designed for gynaecology use during the inspection, operation and delivery. It requires attachment clamp EST-100111

3) Cod. **EST-100182**

Leg Support

(1 Pair included as standard). 1 Pair. Integral polypad, antistatic, stainless steel. It requires attachment clamp EST-100111. Optional pair of velcro strap belts EST-100101



2

4) Cod. **EST-100183**

Handle

1 Pair. For women grasping during inspection and delivery.

5) Cod. **EST-100002**

Gyn aiding table/leg section

Detachable, for gynaecology surgery, delivery, giving support to doctors during dystocia. One section type.



3

6) Cod. **EST-100185.1**

Liquid collection basin without drain

Made of stainless steel. Attachment to table column, Basin size 330x265x150 mm (WxDxH)

Cod. **EST-100185.2**

Liquid collection basin with drain

Made of stainless steel, with drainage tube. Attachment to table. Attachment to table column, with outlet and plastic tube. Basin size 330x265x150 mm (WxDxH)

Cod. **EST-100185.B**

Waste bucket 20L

Made of stainless steel

Cod. **EST-100185.T**

Mobile waste bucket 20L

Made of stainless steel, on casters



6

Positioning aids



1

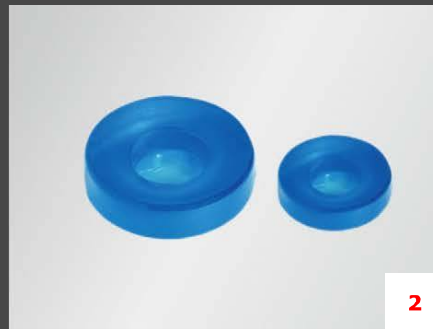

2



3

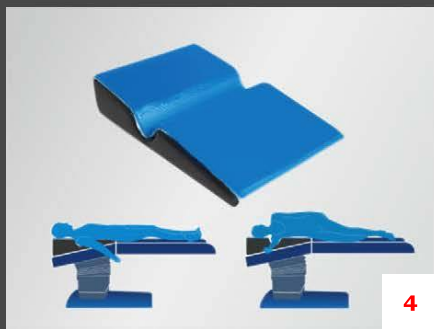

4



5



6

1) Cod. EST-101001

Adult gel head rest for prone position

Adult size, anatomically designed to maintain the patient's head in a comfortable face down position. Output for ET tubes on both sides. Size 280x240x140mm (WxDxH)

Cod. EST-101002

Pediatric gel head rest for prone position

Pediatric size, anatomically designed to maintain the patient's head in a comfortable face down position. Output for ET tubes on both sides. Size 250x200x100mm (WxDxH)

2) Cod. EST-101003

Adult gel head ring for supine position

Adult size, closed type, it protects head and ears during surgery in supine position. Size 200x50mm

Cod. EST-101004

Pediatric gel head ring for supine position

Pediatric size, closed type, it protects head and ears during surgery in supine position. Size 140x30mm

3) Cod. EST-101005

Adult gel head open ring for lateral position

Adult size, open type, it provides stability and protection to the patient's face during surgery in lateral position. Size 200x55mm

Cod. EST-101006

Pediatric gel head open ring for lateral position

Adult size, open type, it provides stability and protection to the patient's face during surgery in lateral position. Size 140x35mm

4) Cod. EST-101007

Gel pad for lateral positioning

For safe lateral position, to relieve pressure on the shoulder joint and protect the nerve tracts, for surgical interventions on the hip, on the shoulder or on the kidney. Size 700x500x160mm (WxDxH)

5) Cod. EST-101008

Thyroid gland positioning pad

Designed to protect and support neck in the thyroid and neck surgery, the pad aids to fully extend operation vision field for surgeons. Size 480x390x90mm (WxDxH)

6) Cod. EST-101009

Gel heel pads

1 Pair. To support the Achilles area and relieve the pressure on the patients heels during lengthy surgical procedures. Size 180x100x70 mm (WxDxH)



Positioning aids



7) Cod. **EST-101110**
Full body pad

Full body pad set to relieve patient pressure during the operation

8) Cod. **EST-101111**
Tunnel cushion

For lateral patient positioning, to prevent the risk of positioning damage to the patient's legs. Antistatic, covered pad with special foam core of 70mm thickness. Size 650x400x220mm (WxDxH)

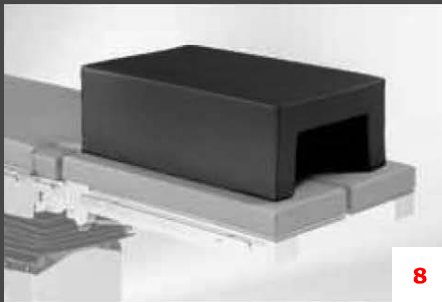

9) Cod. **EST-101112**
Double wedge pad

For supine patient positioning, designed to prevent brachial plexus paralysis and to stabilize the head. Size 440x500x100 mm (WxDxH)

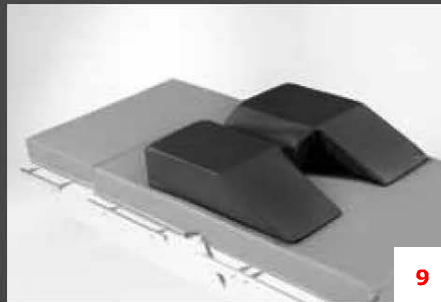

10) Cod. **EST-101113**
Cushion

Antistatic covered poly pad. Size 130x504x504mm (WxDxH)



11) Cod. **EST-101114**
Intervertebral disk pad

Radiotransparent for intervertebral disk operations. Special foam with cover. Abdominal opening 270x240mm. Size 640x420x100mm (WxDxH)



12) Cod. **EST-101115**
Intervertebral disk pad

For intervertebral disk operations. To put the patient in prone position.



Pulse Healthcare Technology
House: 11/1, Shahid Minar Road
Kallyanpur, Dhaka-1216, Bangladesh.
Mobile: +8801708008061
e-mail: info@pht.com.bd
web: www.pht.com.bd



ESSE3 srl, Via Garibaldi 30
14022 Castelnuovo D.B. (AT)
Tel +39 011 99 27 706
Fax +39 011 99 27 506
e-mail: esse3@chierinet.it
web: www.esse3-medical.com

